

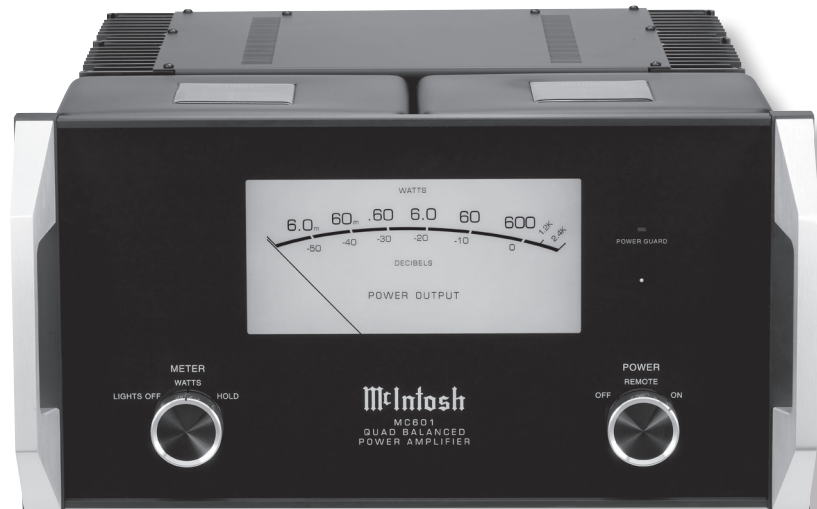

McIntosh Laboratory, Inc. 2 Chambers Street Binghamton, New York 13903-2699 Phone: 607-723-3512 [www.mcintoshlabs.com](http://www.mcintoshlabs.com)

MC601  
Quad Balanced  
Power Amplifier  
Owner's Manual



The lightning flash with arrowhead, within an equilateral triangle, is intended to alert the user to the presence of uninsulated “dangerous voltage” within the product’s enclosure that may be of sufficient magnitude to constitute a risk of electric shock to persons.

**WARNING - TO REDUCE RISK OF FIRE OR ELECTRICAL SHOCK, DO NOT EXPOSE THIS EQUIPMENT TO RAIN OR MOISTURE.**



**AVIS** RISQUE DE CHOC ELECTRIQUE - NE PAS OUVRIR.

**NO USER-SERVICEABLE PARTS INSIDE. REFER SERVICING TO QUALIFIED PERSONNEL.**

The exclamation point within an equilateral triangle is intended to alert the user to the presence of important operating and maintenance (servicing) instructions in the literature accompanying the appliance.

**To prevent the risk of electric shock, do not remove cover or back. No user-serviceable parts inside.**

## IMPORTANT SAFETY INSTRUCTIONS!

### PLEASE READ THEM BEFORE OPERATING THIS EQUIPMENT.

1. Read these instructions.
2. Keep these instructions.
3. Heed all warnings.
4. Follow all instructions.
5. Do not use this apparatus near water.
6. Clean only with a dry cloth.
7. Do not block any ventilation openings. Install in accordance with the manufacturer’s instructions.
8. Do not install near any heat sources such as radiators, heat registers, stoves, or other apparatus (including amplifiers) that produce heat.
9. Do not defeat the safety purpose of the polarized or grounding-type plug. A polarized plug has two blades with one wider than the other. A grounding type plug has two blades and a

third grounding prong. The wide blade or the third prong are provided for your safety. If the provided plug does not fit into your outlet, consult an electrician for replacement of the obsolete outlet.

10. Protect the power cord from being walked on or pinched particularly at plugs, convenience receptacles, and the point where they exit from the apparatus.
11. Only use attachments/accessories specified by the manufacturer.
12. Use only with the cart, stand, tripod, bracket, or table specified by the manufacturer, or sold with the apparatus. When a cart is used, use caution when moving the cart/apparatus combination to avoid injury from tip-over.
13. Unplug this apparatus during lightning storms or when unused for long periods of time.
14. Refer all servicing to qualified service personnel. Servicing is required when the apparatus has been damaged in any way, such as power-



supply cord or plug is damaged, liquid has been spilled or objects have fallen into the apparatus, the apparatus has been exposed to rain or moisture, does not operate normally, or has been dropped.

15. Do not expose this equipment to dripping or splashing and ensure that no objects filled with liquids, such as vases, are placed on the equipment.
16. To completely disconnect this equipment from the a.c. mains, disconnect the power supply cord plug from the a.c. receptacle.
17. The mains plug of the power supply cord shall remain readily operable.
18. Do not expose batteries to excessive heat such as sunshine, fire or the like.
19. Connect mains power supply cord only to a mains socket outlet with a protective earthing connection.

## Thank You

Your decision to own this McIntosh MC601 Quad Balanced Power Amplifier ranks you at the very top among discriminating music listeners. You now have “The Best.” The McIntosh dedication to “Quality,” is assurance that you will receive many years of musical enjoyment from this unit.

Please take a short time to read the information in this manual. We want you to be as familiar as possible with all the features and functions of your new McIntosh.

## Please Take A Moment

The serial number, purchase date and McIntosh Dealer name are important to you for possible insurance claim or future service. The spaces below have been provided for you to record that information:

Serial Number: \_\_\_\_\_

Purchase Date: \_\_\_\_\_

Dealer Name: \_\_\_\_\_

## Technical Assistance

If at any time you have questions about your McIntosh product, contact your McIntosh Dealer who is familiar with your McIntosh equipment and any other brands that may be part of your system. If you or your Dealer wish additional help concerning a suspected problem, you can receive technical assistance for all McIntosh products at:

McIntosh Laboratory, Inc.  
2 Chambers Street  
Binghamton, New York 13903  
Phone: 607-723-1545  
Fax: 607-724-0549

Copyright 2011, 2012, 2013 © by McIntosh Laboratory, Inc.

## Customer Service

If it is determined that your McIntosh product is in need of repair, you can return it to your Dealer. You can also return it to the McIntosh Laboratory Service Department. For assistance on factory repair return procedure, contact the McIntosh Service Department at:

McIntosh Laboratory, Inc.  
2 Chambers Street  
Binghamton, New York 13903  
Phone: 607-723-3515  
Fax: 607-723-1917

## Table of Contents

Safety Instructions .....	2
Thank You and Please Take a Moment.....	3
Technical Assistance and Customer Service .....	3
Table of Contents .....	3
General Information .....	3
Connector and Cable Information .....	4
Introduction.....	4
Performance Features .....	4
Dimensions .....	5
Installation .....	6
Rear Panel Connections and Switch .....	7
Output Terminals and How to Connect.....	8-9
Output Terminals and How to Connect for Bi-Amp .....	10-11
Front Panel Displays and Controls.....	12
How to Operate.....	13
Technical Description .....	14-17
Specifications.....	18
Packing Instruction.....	19

## General Information

1. For additional connection information, refer to the owner’s manual(s) for any component(s) connected to the MC601.

2. The MC601 mutes the speaker output for approximately two seconds when first turned on.
3. For the best performance and safety it is important to always match the impedance of the Loudspeaker to the Power Amplifier connections. Refer to “How to Connect” pages 8 thru 11.

*Note: The impedance of a Loudspeaker actually varies as the Loudspeaker reproduces different frequencies. As a result, the nominal impedance rating of the Loudspeaker (usually measured at a midrange frequency) might not always agree with the impedance of the Loudspeaker at low frequencies where the greatest amount of power is required. Contact the Loudspeaker Manufacturer for additional information about the actual impedance of the Loudspeaker before connecting it to the McIntosh MC601.*

4. In the event the MC601 over heats, due to improper ventilation and/or high ambient temperature, the protection circuits will activate. The Front Panel Power Guard LED will continuously indicate ON and the audio will be muted. When the MC601 has returned to a safe operating temperature, normal operation will resume.
5. When discarding the unit, comply with local rules or regulations. Batteries should never be thrown away or incinerated but disposed of in accordance with the local regulations concerning battery disposal.
6. For additional information on the MC601 and other McIntosh Products please visit the McIntosh Web Site at [www.mcintoshlabs.com](http://www.mcintoshlabs.com).



## Connector and Cable Information

### XLR Connectors

Below is the Pin configuration for the XLR Balanced Input, Input/Output Connectors on the MC601. Refer to the diagram for connection:

- PIN 1: Shield/Ground
- PIN 2: + Input/Output
- PIN 3: - Input/Output

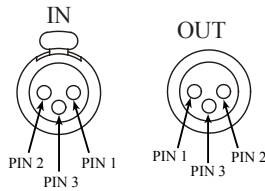

### Power Control Connector

The MC601 Power Control Input receives an On/Off signal from +5 to +12 volts. The Power Control Output will in turn provide a +12 volt Output Signal with a total current up to 50mA. An additional connection is for controlling the illumination of the MC601 Power Output Meters. The 1/8 inch stereo mini phone plug connects to a McIntosh Preamplifier or A/V Control Center Power Control Output.

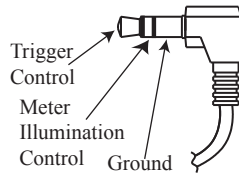

## Introduction

Now you can take advantage of traditional McIntosh standards of excellence in the MC601 Quad Balanced Power Amplifier. The 600 watts high current output will drive any high quality Loudspeaker. The MC601 reproduction is sonically transparent and absolutely accurate. The McIntosh Sound is "The Sound of the Music Itself."

## Performance Features

### • Power Output

The MC601 is a Power Amplifier with a capability of 600 watts into 2, 4 or 8 ohm speakers with less than 0.005% distortion. The Power Amplifier Circuitry uses Thermal Trak<sup>1</sup> Output Transistors for lower distortion and cool operation.

### • Quad Balanced Circuitry

The MC601 is fully balanced from input to output. It consists of two matched power amplifiers operating in push-pull with their outputs combined in a McIntosh Autoformer. The Quad Balanced configuration cancels virtually all distortion.

### • Patented Autoformer

McIntosh designed and manufactured Output Autoformers provide an ideal match between the amplifier output stages and speaker loads of 2, 4 and 8 ohms. The Autoformers also provide perfect DC protection for your valuable loudspeakers.

### • Balanced and Unbalanced Inputs

Balanced connections guard against induced noise and allow long cable runs without compromising sound quality.

### • Power Guard

The patented McIntosh Power Guard circuit prevents the amplifier from being over driven into clipping, with its harsh distorted sound that can also damage your valuable loudspeaker.

### • Sentry Monitor and Thermal Protection

McIntosh Sentry Monitor power output stage protection circuits ensure the MC601 will have a long and

trouble free operating life. Built-in Thermal Protection Circuits guard against overheating.

### • Special Power Supply

A very large Power Transformer and Large Capacitors ensure stable noise free operation even though the power line varies.

### • Illuminated Power Meter

The Illuminated Power Output Watt Meter on the MC601 is peak responding, and indicates the true power output of the amplifier. The Peak Watt Hold Mode allows the meter to temporarily stay at the highest power output and then slowly decay. The Front Panel Meter Illumination may be switched Off at any time.

### • McIntosh Custom Binding Posts

McIntosh patent pending gold plated output terminals deliver high current output. They accept large diameter wire and spade lugs. Banana plugs may also be used only in the United States and Canada.

### • Fiber Optic Solid State Front Panel Illumination

The even Illumination of the Front Panel is accomplished by the combination of custom designed Fiber Optic Light Diffusers and extra long life Light Emitting Diodes (LEDs).

### • Glass Front Panel and Super Mirror Chassis Finish

The famous McIntosh Illuminated Glass Front Panel and the Stainless Steel Chassis with Super Mirror Finish ensures the pristine beauty of the MC601 will be retained for many years.

<sup>1</sup>ThermalTrak™ and ON Semiconductor are trademarks of Semiconductor Components Industries, LLC

**Dimensions**

The following dimensions can assist in determining the best location for your MC601.

**Front View of the MC601**

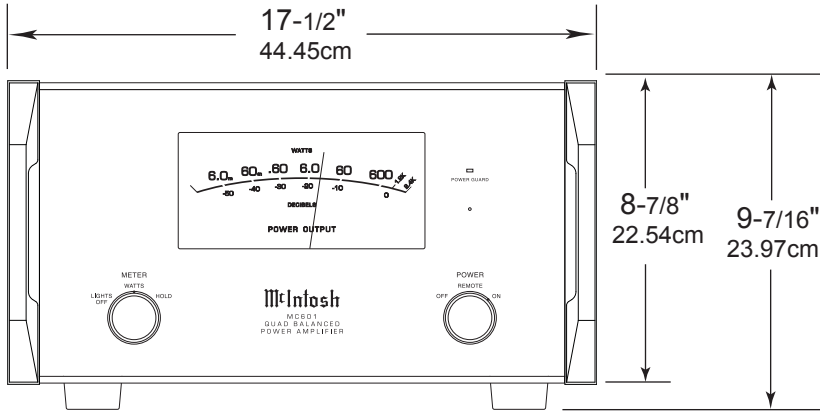

**Rear View of the MC601**

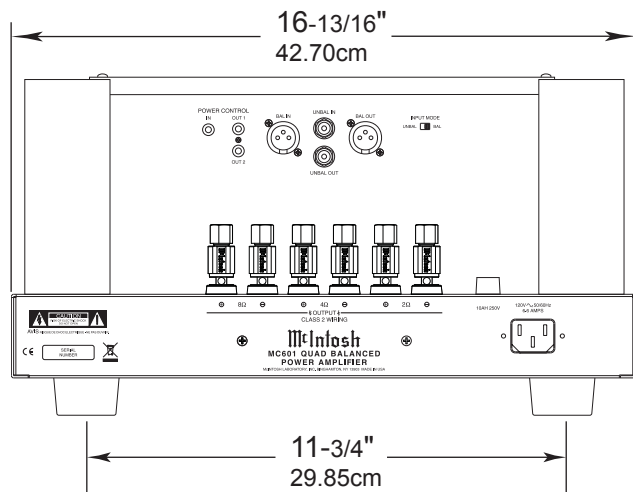

**Side View of the MC601**

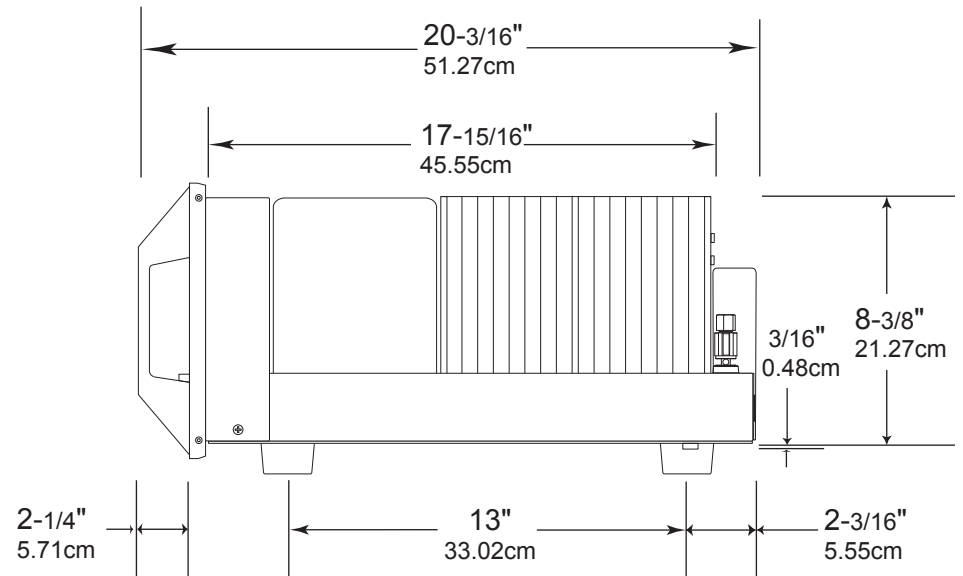

### Installation

The MC601 can be placed upright on a table or shelf, standing on its four feet. It also can be custom installed in a piece of furniture or cabinet of your choice. The four feet may be removed from the bottom of the MC601 when it is custom installed as outlined below. The four feet together with the mounting screws should be retained for possible future use if the MC601 is removed from the custom installation and used free standing. The required panel cutout, ventilation cutout and unit dimensions are shown.

Always provide adequate ventilation for your MC601. Cool operation ensures the longest possible operating life for any electronic instrument. Do not install the MC601 directly above a heat generating component such as a high powered amplifier. If all the components are installed in a single cabinet, a quiet running ventilation fan can be a definite asset in maintaining all the system components at the coolest possible operating temperature.

A custom cabinet installation should provide the following minimum spacing dimensions for cool operation.

Allow at least 6 inches (15.24cm) above the top, 2 inches (5.08cm) below the bottom, 3 inches (7.62cm) behind the rear panel and 2 inches (5.08cm) on each side of the Power Amplifier, so that airflow is not obstructed. Allow 2-1/2 inches (6.35 cm) in front of the mounting<sup>1</sup> panel for clearance. **Be sure to cut out a ventilation hole in the mounting shelf according to the dimensions in the drawing.**

<sup>1</sup> When the MC601 is installed together with other McIntosh Components, check clearances on all components before proceeding.

MC601 Front Panel  
Custom Cabinet Cutout

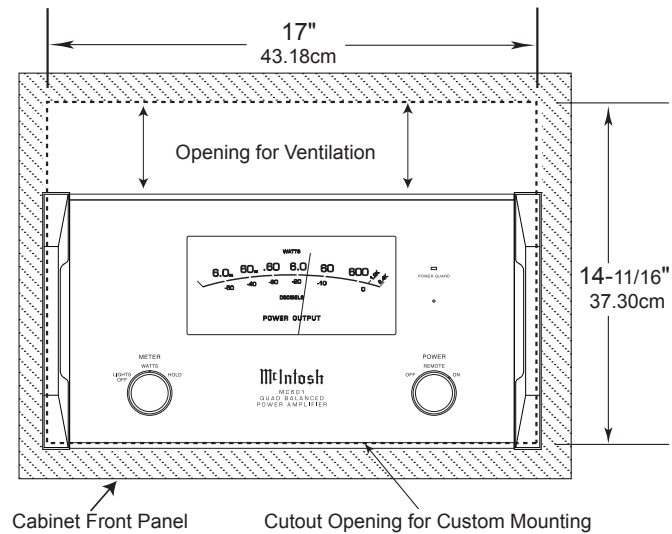

MC601 Side View  
in Custom Cabinet

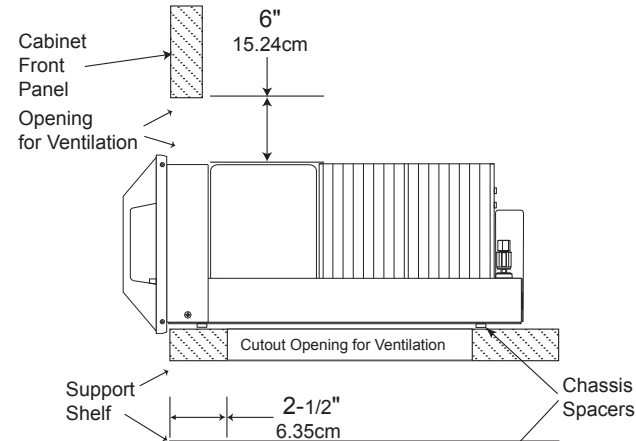

MC601 Bottom View  
in Custom Cabinet

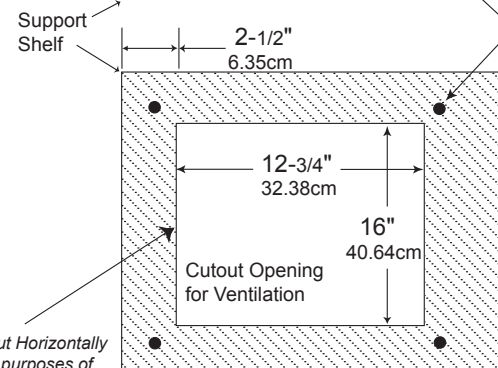

Note: Center the cutout horizontally on the unit. For purposes of clarity, the above illustration is not drawn to scale.



# Rear Panel Connections and Switch

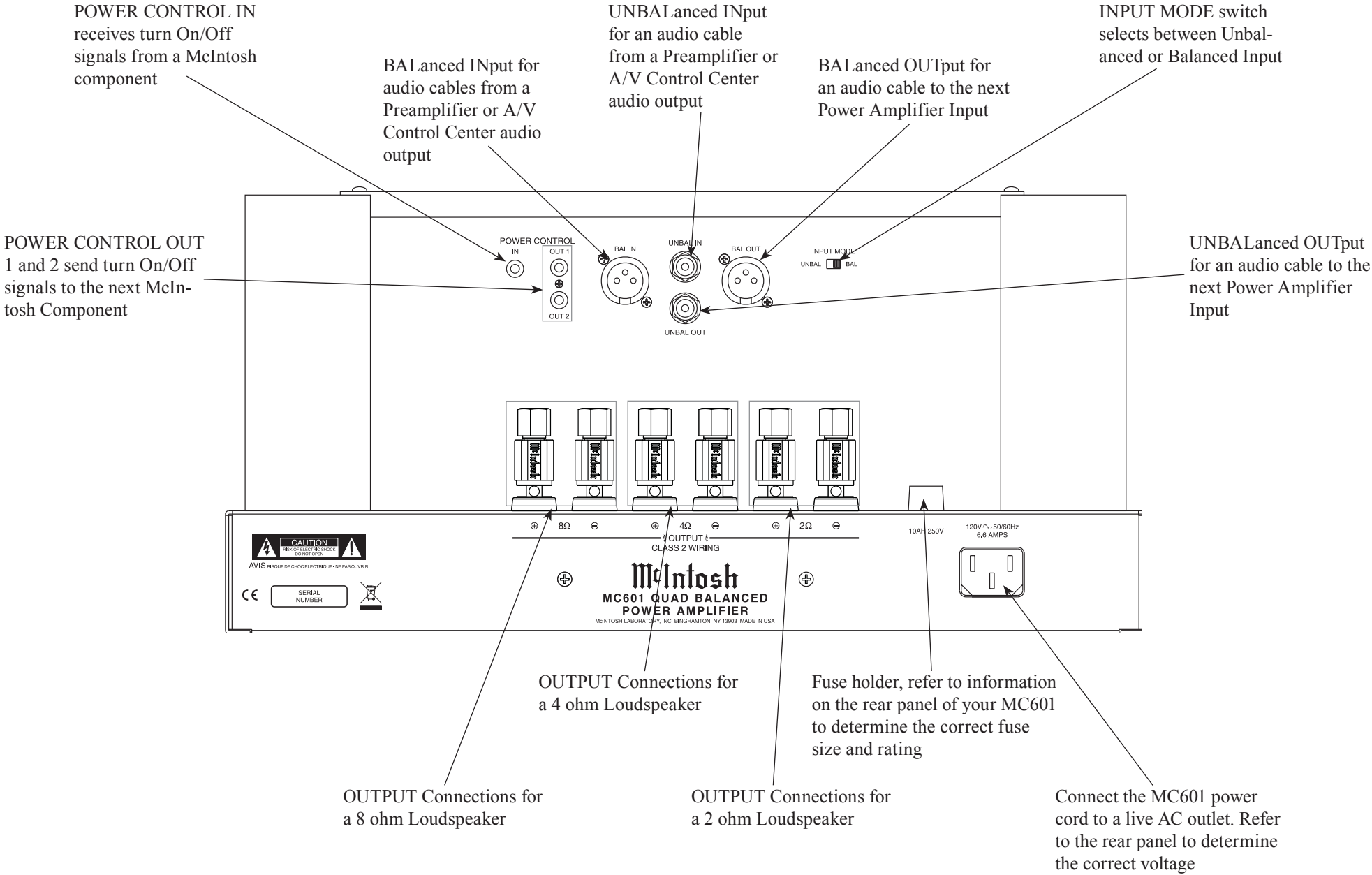

**Caution:** The Loudspeaker ⊖ Negative Connections are above chassis ground. Do not combine any connections together, ground them or connect with another MC601.



## Output Terminals

When connecting the Loudspeaker Hookup Cables to the MC601 Power Amplifier Output Terminals please follow the steps below:

1. Rotate the top of the Output Terminal Post counterclockwise until an opening appears. Refer to figures A and B.
2. Insert the Loudspeaker hookup cable into the Output Terminal Post opening or the cable spade lug around the center post of the Output Terminal. Refer to figure C.
3. Rotate the top of the Output Terminal Post clockwise until it is finger tight. Refer to figure D.
4. Place the supplied McIntosh Wrench over the top of the Output Terminal and rotate it one quarter of a turn (90°) to secure the Loudspeaker Cable Connection. **Do not over tighten.** Refer to figure E.

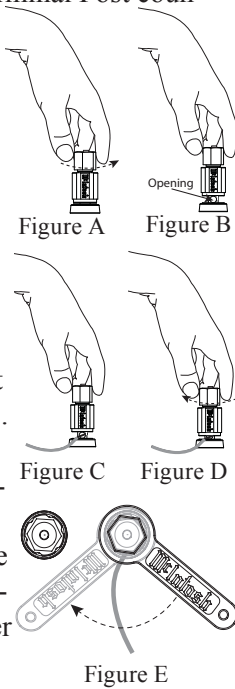

## How to Connect

**Caution: Do not connect the AC Power Cord to the MC601 Rear Panel until after the Loudspeaker Connections are made and the protective Terminal Connections Cover is installed. Failure to observe this could result in Electric Shock.**

The connection instructions below, together with the MC601 Connection Diagram located on the separate folded sheet “Mc1A”, is an example of a typical audio system. Your system may vary from this, however the actual components would be connected in a similar manner. For additional information refer to “Connector and Cable Information” on page 4.

1. For Remote Power Control, connect a power control cable from the Audio Preamplifier or A/V Control Center Power Control Output 1 to the Amplifier POWER CONTROL IN.

*Note: When a Power Control Cable is connected between the MC601 and Preamplifier (or A/V Control Center), the AUTO OFF Feature is bypassed. Refer to page 13.*

2. Connect XLR cables from the Balanced Output 1 (R, refer to note 2 below) of an Audio Preamplifier or A/V Control Center to the Amplifier BALANCED INput. Place the INPUT MODE Switch in the BALANCED Position.

*Notes: 1. An optional hookup is to use unbalanced cable and place the INPUT MODE Switch in the UNBALANCED Position.*

*2. When multiple MC601s are used in a Stereo or Multichannel System, match up the Preamplifier or A/V Control Center Channel Output designation to each MC601 with Loudspeaker and the Loudspeaker location in the room.*

3. Using a suitable tool remove the two screws from the MC601 Rear Panel and temporarily place them in a safe place. Refer to figure 1.

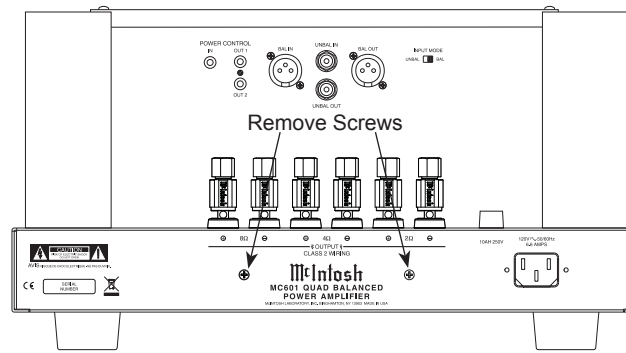

Figure 1

This McIntosh MC601 Quad Balanced Power Amplifier is designed for Loudspeakers with an impedance of 2 ohms, 4 ohms or 8 ohms. Connect a single Loudspeaker only to the Output Terminals.

When connecting Loudspeakers to the MC601 it is very important to use cables of adequate size, so there is little to no power loss in the cables. The size is specified in Gauge Numbers or AWG (American Wire Gauge). The smaller the Gauge number, the larger the wire size:

Loudspeaker Cable Distance vs Wire Gauge Guide			
Loudspeaker Impedance	25 feet (7.62 meters) or less	50 feet (15.24 meters) or less	100 feet (30.48 meters) or less
2 Ohms	12AWG	10AWG	8AWG
4 Ohms	14AWG	12AWG	10AWG
8 Ohms	16AWG	14AWG	12AWG

4. Prepare the Loudspeaker Hookup Cable for attachment to the MC601 Power Amplifier:

Bare wire cable ends:

Carefully remove sufficient insulation from the cable ends, refer to figures 2, 3 & 4. If the cable is stranded, carefully twist the strands together as tightly as possible.

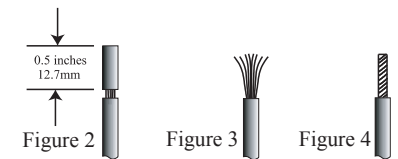

- Notes: 1. If desired, the twisted ends can be tinned with solder to keep the strands together.*
- 2. The prepared bare wire cable ends may be inserted into spade lug connectors.*
- 3. Banana plugs are for use in the United States and Canada only.*



## Banana Plugs are for use in the United States and Canada only:

5. Locate the Terminal Connections Cover from the inside of the MC601 shipping carton. Insert the just prepared Loudspeaker hookup cables thru the cover opening on the right side. Refer to figure 5.

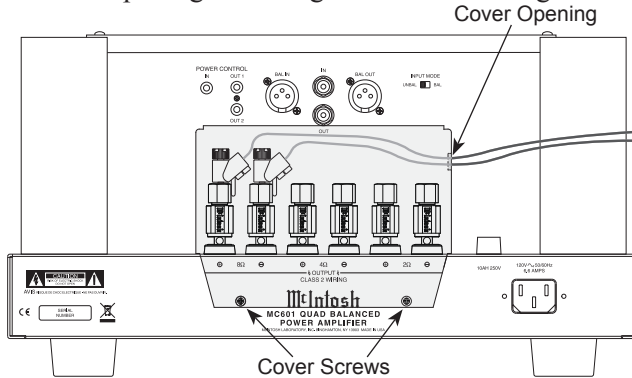

Figure 5 (Inside USA and Canada)

6. Attach the previously prepared bare wire cable ends into the banana plugs and secure the connections. Refer to figure F.

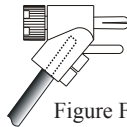

Figure F

7. Rotate the top of the Output Terminal Post clockwise until it is finger tight. Refer to figure G. Then using the McIntosh Wrench, rotate the top of the Output Terminal one quarter of a turn (90°). **Do not over tighten.** Refer to figure E.

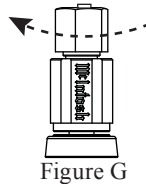

Figure G

8. Referring to figure H, connect the Loudspeaker hookup cables with banana plugs into the hole at the top of the MC601 Negative and Positive Output Terminals. The terminals are identified as 2Ω (ohms), 4Ω (ohms) or 8Ω

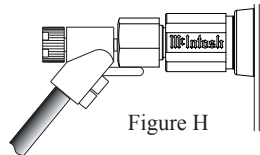

Figure H

(ohms) connection to match the impedance of the Loudspeaker, being careful to observe the correct polarities.

*Note: The illustration in figure 5 is connections for 8Ω (ohms) Loudspeakers.*

If the Loudspeaker's impedance is in-between the available connections, use the nearest lower impedance connection. Refer to "General Information" Note 4 on page 3 for additional information.

**WARNING: Loudspeaker terminals are hazardous live and present a risk of electric shock. For additional instruction on making Loudspeaker Connections contact your McIntosh Dealer or McIntosh Technical Support.**

9. Attach the Terminal Connections Cover to the MC601 Rear Panel with the previously removed Screws. Refer to figure 5.
10. Connect the MC601 power cord to an active AC outlet.

## Spade Lug or Wire Connections:

11. Locate the Terminal Connections Cover from the inside of the MC601 shipping carton. Insert the just prepared Loudspeaker hookup cables thru the cover opening on the right side. Refer to figure 6.
12. Connect the Loudspeaker hookup cables to the MC601 Negative Output Terminal and Positive Output Terminal identified as 2Ω (ohms), 4Ω (ohms) or 8Ω (ohms) connection to match the impedance of the Loudspeaker, being careful to observe the correct polarities. Insert the spade lug connector or prepared section of the cable end into the terminal side access hole, and tighten the terminal cap until the cable is firmly clamped into the terminals so the lugs or wire cannot slip out. Refer to figures 7 and 8.

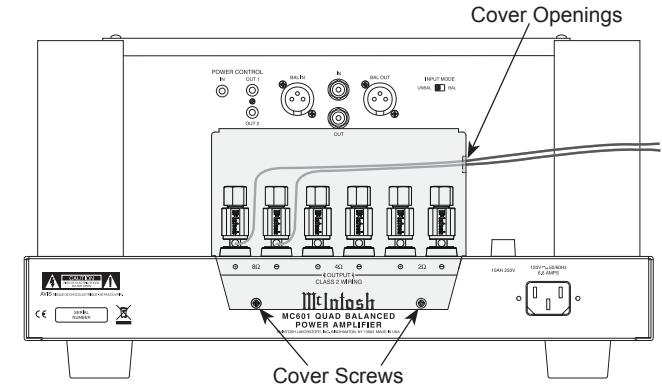

Figure 6 (Outside USA and Canada)

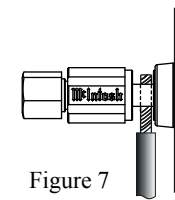

Figure 7

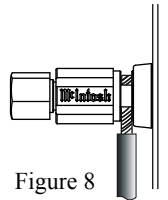

Figure 8

*Note: The illustration in figure 6 is connections for 8Ω (ohms) Loudspeakers.*

If the Loudspeaker's impedance is in-between the available connections, use the nearest lower impedance connection. Refer to "General Information" Note 4 on page 3 for additional information.

**WARNING: Loudspeaker terminals are hazardous live and present a risk of electric shock. For additional instruction on making Loudspeaker Connections contact your McIntosh Dealer or McIntosh Technical Support.**

13. Attach the Terminal Connections Cover to the MC601 Rear Panel with the previously removed Screws. Refer to figure 6.
14. Connect the MC601 power cord to an active AC outlet.



## Output Terminals

When connecting the Loudspeaker Hookup Cables to the MC601 Power Amplifier Output Terminals please follow the steps below:

1. Rotate the top of the Output Terminal Post counterclockwise until an opening appears. Refer to figures A and B.
2. Insert the Loudspeaker hookup cable into the Output Terminal Post opening or the cable spade lug around the center post of the Output Terminal. Refer to figure C.
3. Rotate the top of the Output Terminal Post clockwise until it is finger tight. Refer to figure D.
4. Place the supplied McIntosh Wrench over the top of the Output Terminal and rotate it one quarter of a turn (90°) to secure the Loudspeaker Cable Connection. **Do not over tighten.** Refer to figure E.

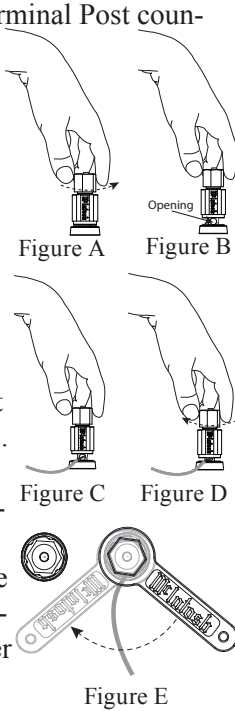

## How to Connect for Bi-Amp

**Caution:** Do not connect the AC Power Cord to the MC601 Rear Panel until after the Loudspeaker Connections are made and the protective Terminal Connections Cover is installed. Failure to observe this could result in Electric Shock.

The connection instructions below, together with the MC601 Connection Diagram located on the separate folded sheet “Mc1B”, is an example of a typical audio system. Your system may vary from this, however the actual components would be connected in a similar manner. For additional information refer to “Connector and Cable Information” on page 4.

1. For Remote Power Control, connect a power control cable from the Audio Preamplifier or A/V Control Center Power Control Output 1 to Amplifier One POWER CONTROL IN.

*Note: When the Power Control Cable is connected between the MC601 and Preamplifier or A/V Control Center, the AUTO OFF Power Save Feature is automatically disabled.*

2. Connect a power control cable from Amplifier One Power Control OUTPUT 1 to Amplifier Two POWER CONTROL IN.
3. Connect XLR cables from the Balanced Output 1 (R, refer to note 2 below) of an Audio Preamplifier or A/V Control Center to Amplifier BALANCED INPUT. Place the INPUT MODE Switch in the BALANCED Position.

*Notes: 1. An optional hookup is to use unbalanced cable and place the INPUT MODE Switch in the UNBALANCED Position.*

*2. When multiple MC601s are used in a Stereo or Multichannel System, match up the Preamplifier or A/V Control Center Channel Output designation to each MC601 with Loudspeaker and the Loudspeaker location in the room.*

4. Connect XLR cables from Amplifier One Audio BALANCED OUTPUT to Amplifier Two BALANCED INPUT.
5. Using a suitable tool remove the two screws from the MC601 Rear Panel and temporarily place them in a safe place. Refer to figure 1.

This McIntosh MC601 Quad Balanced Power Amplifier is designed for Loudspeakers with an impedance of 2 ohms, 4 ohms or 8 ohms. Connect a single Loudspeaker only to the Output Terminals.

When connecting Loudspeakers to the MC601 it is very important to use cables of adequate size, so there is little to no power loss in the cables. The size is

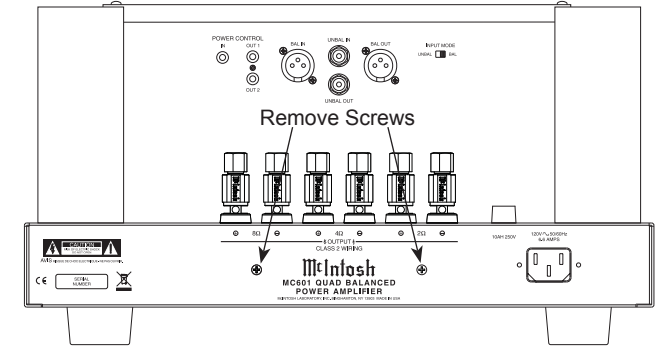

Figure 1

specified in Gauge Numbers or AWG (American Wire Gauge). The smaller the Gauge number, the larger the wire size:

Loudspeaker Cable Distance vs Wire Gauge Guide			
Loudspeaker Impedance	25 feet (7.62 meters) or less	50 feet (15.24 meters) or less	100 feet (30.48 meters) or less
2 Ohms	12AWG	10AWG	8AWG
4 Ohms	14AWG	12AWG	10AWG
8 Ohms	16AWG	14AWG	12AWG

6. Prepare the Loudspeaker Hookup Cable for attachment to the MC601 Power Amplifier:

### Bare wire cable ends:

Carefully remove sufficient insulation from the cable ends, refer to figures 2, 3 & 4. If the cable is stranded, carefully twist the strands together as tightly as possible.

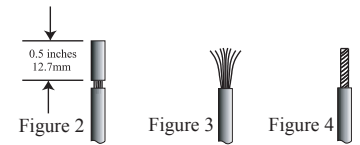

- Notes: 1. If desired, the twisted ends can be tinned with solder to keep the strands together.*
- 2. The prepared bare wire cable ends may be inserted into spade lug connectors.*
- 3. Banana plugs are for use in the United States and Canada only.*

## Banana Plugs are for use in the United States and Canada only:

7. Locate the Terminal Connections Cover from the inside of the MC601 shipping carton. Insert the just prepared Loudspeaker hookup cables thru the cover opening on the right side. Refer to figure 5.

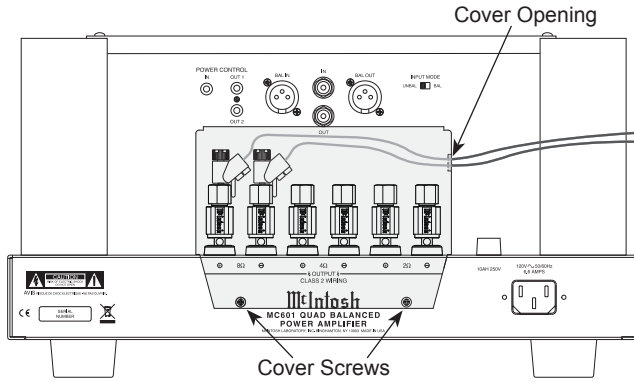

Figure 5 (Inside USA and Canada)

8. Attach the previously prepared bare wire cable ends into the banana plugs and secure the connections. Refer to figure F.

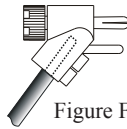

Figure F

9. Rotate the top of the Output Terminal Post clockwise until it is finger tight. Refer to figure G. Then using the McIntosh Wrench, rotate the top of the Output Terminal one quarter of a turn (90°). **Do not over tighten.** Refer to figure E.

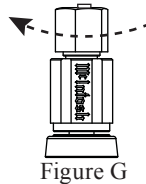

Figure G

10. Referring to figure H, connect the Loudspeaker hookup cables with banana plugs into the hole at the top of the MC601 Negative and Positive Output Terminals. The terminals are identified as 2Ω (ohms), 4Ω (ohms)

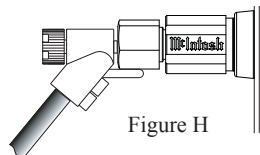

Figure H

or 8Ω (ohms) connection to match the impedance of the Loudspeaker, being careful to observe the correct polarities.

*Note: The illustration in figure 5 is connections for 8Ω (ohms) Loudspeakers.*

If the Loudspeaker's impedance is in-between the available connections, use the nearest lower impedance connection. Refer to "General Information" Note 4 on page 3 for additional information.

**WARNING: Loudspeaker terminals are hazardous live and present a risk of electric shock. For additional instruction on making Loudspeaker Connections contact your McIntosh Dealer or McIntosh Technical Support.**

11. Attach the Terminal Connections Cover to the MC601 Rear Panel with the previously removed Screws. Refer to figure 5.
12. Connect the MC601 power cord to an active AC outlet.

## Spade Lug or Wire Connections:

13. Locate the Terminal Connections Cover from the inside of the MC601 shipping carton. Insert the just prepared Loudspeaker hookup cables thru the cover opening on the right side. Refer to figure 6.
14. Connect the Loudspeaker hookup cables to the MC601 Negative Output Terminal and Positive Output Terminal identified as 2Ω (ohms), 4Ω (ohms) or 8Ω (ohms) connection to match the impedance of the Loudspeaker, being careful to observe the correct polarities. Insert the spade lug connector or prepared section of the cable end into the terminal side access hole, and tighten the terminal cap until the cable is firmly clamped into the terminals so the lugs or wire cannot slip out. Refer to figures 7 and 8.

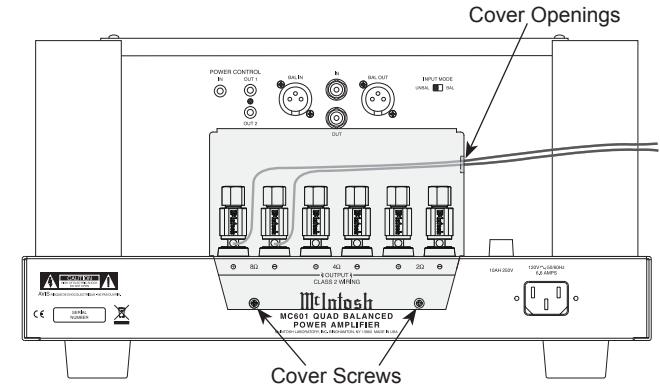

Figure 6 (Outside USA and Canada)

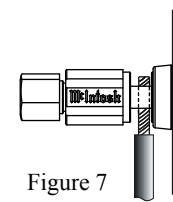

Figure 7

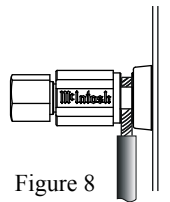

Figure 8

*Note: The illustration in figure 6 is connections for 8Ω (ohms) Loudspeakers.*

If the Loudspeaker's impedance is in-between the available connections, use the nearest lower impedance connection. Refer to "General Information" Note 4 on page 3 for additional information.

**WARNING: Loudspeaker terminals are hazardous live and present a risk of electric shock. For additional instruction on making Loudspeaker Connections contact your McIntosh Dealer or McIntosh Technical Support.**

15. Attach the Terminal Connections Cover to the MC601 Rear Panel with the previously removed Screws. Refer to figure 6.
16. Connect the MC601 power cord to an active AC outlet.

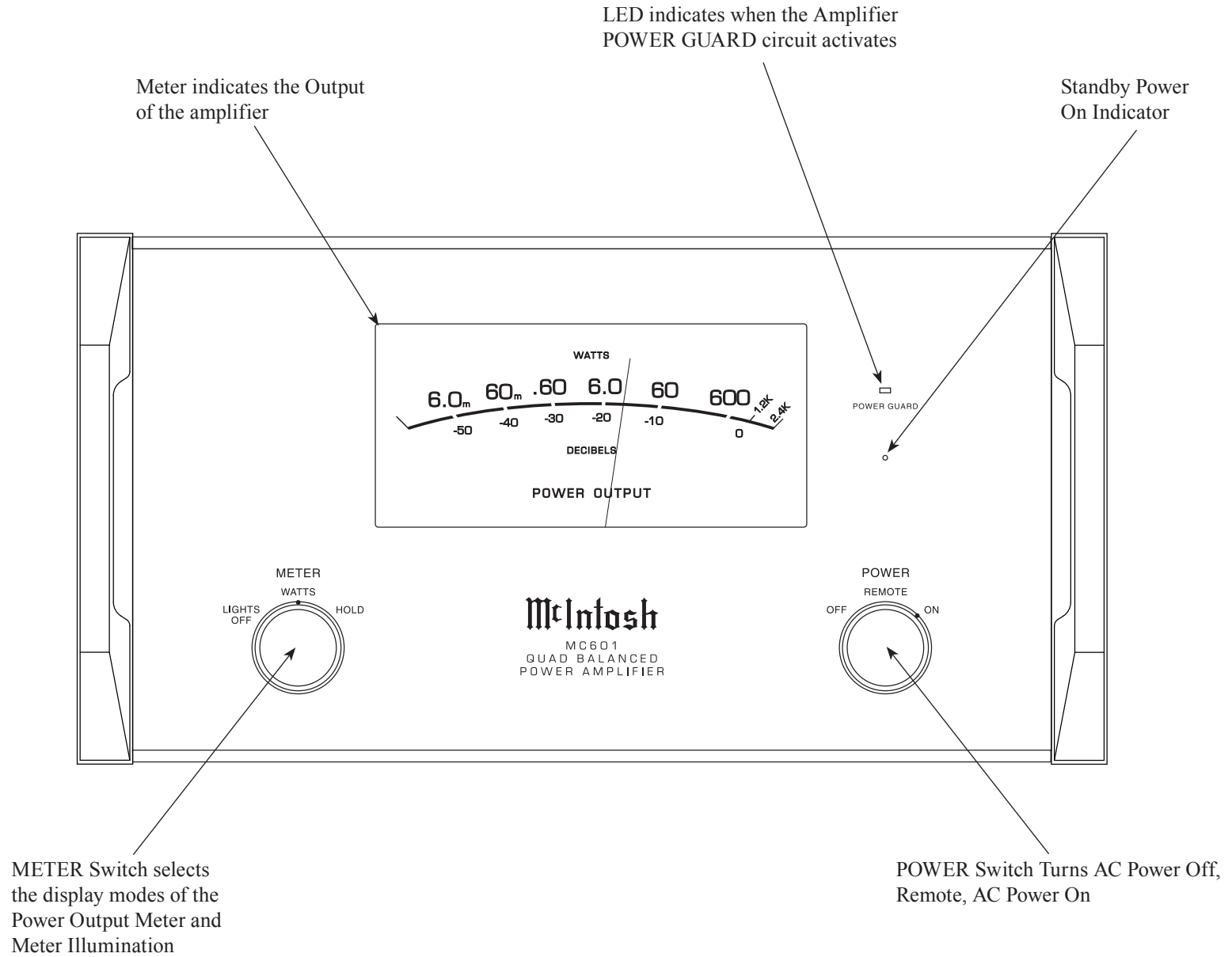



## How to Operate

### Power On

To have the MC601 automatically turn On or Off when a control center turns on or off, rotate the power switch to the Remote position. For manual operation, rotate the power switch to the On or Off position as desired. Refer to figure 8.

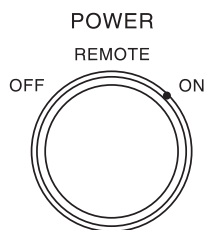

Figure 8

*Note: There must be a power control connection between the MC601 and the Audio Preamplifier or A/V Control Center, in order for the remote power turn-on to function.*

### Auto Off

The MC601 incorporates a Power Save Feature to automatically switch power Off to the Power Amplifier approximately 30 minutes after there has been an absence of an audio input signal.

*Note: If the Power Save Feature has activated and switched the MC601 Off, the Power Save Feature can be reset by first placing the POWER Control in the REMOTE Position and then in the ON Position.*

When there is a Power Control Connection between the MC601 and a McIntosh Preamplifier or (A/V Control Center) the Power Save Feature in the MC601 is bypassed.

With the MC601 connected (via Power Control) to a McIntosh Preamplifier (or A/V Control Center) with the Power Save Feature and the feature is active, the MC601 will switch Off with the Preamplifier (or A/V Control Center) after a period of inactivity.

There may be times when it would be desirable to bypass the Power Save Feature. This can be implemented by connecting the Rear Panel POWER CON-

TROL OUTput 1 connector to the POWER CONTROL INput connector using a stereo mini phone cable. Refer to figure 9:

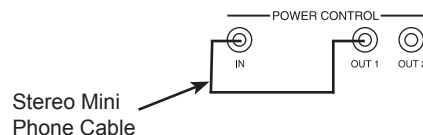

Figure 9

*Note: The POWER CONTROL "OFF" and "ON" positions should be used when there is a cable connected between the Power Control IN and Power Control OUT 1 on the Power Amplifier.*

### Meter Selection

Rotate the meter mode switch to select the meter operation mode you desire. Refer to figures 10 and 11.

Lights Off - Meter illumination is switched Off and the meter will continue to indicate the power output.

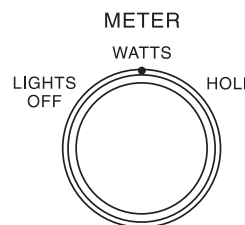

Figure 10

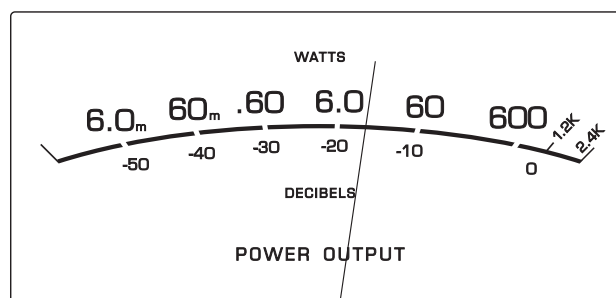

Figure 11

*Note: When Power Control Input of the MC601 is connected to a Audio Preamplifier or A/V Control Center with Remote Meter Illumination Control, the Meter Illumination will automatically be remotely controlled (On/Off) with the METER Switch set to the WATTS or HOLD position.*

Watts- The meter responds to all the musical information being produced by the amplifier. It indicates to an accuracy of at least 95% of the power output with only a single cycle of a 2000Hz tone burst.

Hold - The meter pointer is locked to the highest power peak in a sequence of peaks. It is electronically held to this power level until a higher power peak passes through the amplifier. The meter pointer will then rise to the newer higher indication. If no further power peaks are reached, the meter pointer will very slowly return to its rest position or lower power level. The decay rate is approximately 6dB per minute.

*Note: The MC601 Power Output Meter indicates the actual power delivered to the loudspeakers by responding to the combination of current and voltage output.*

### Input Mode Switch

The Input Mode Switch, which is located on the Rear Panel of the MC601, allows selection of either the Balanced or Unbalanced Input. Refer to figure 12.



Figure 12



## Technical Description

McIntosh Laboratory, the company who introduced the world's first amplifier that could be called "High Fidelity", has done it again. The McIntosh engineering staff has created a power amplifier without compromise, using the most advanced McIntosh circuit design concepts.

The MC601 has a continuous average power output rating of 600 watts and with a peak output current of 90 amperes; making this one of the most advanced amplifiers available today. The distortion limits for the MC601 are no more than 0.005% at rated power output for all frequencies from 20Hz to 20,000Hz.

Typical performance at mid frequencies is less than 0.002%. The true distortion readings on the MC601 are so low, it takes special measuring techniques to make accurate readings. The MC601 can deliver the best possible performance from any type of high quality loudspeaker system. Refer to figure 12.

Creating an amplifier with this level of performance did not come easily. Many months of design, testing and measuring were required. Extensive controlled listening tests, the ultimate form of measuring, were made before the final design was accepted.

### Design Philosophy

The design philosophy incorporated in the MC601 involved several different techniques, all based on sound scientific logic. Every stage of voltage or current amplification must be as linear as possible prior to the use of negative feedback. McIn-

tosh engineers know how to properly design negative feedback circuits so they contribute to the extremely low distortion performance expected from a McIntosh amplifier. The typical McIntosh owner would never accept the approximately 100 times higher distortion of many non-feedback designs.

Double Balanced Push-Pull design is used from input to output. Each half of the amplifier contains complimentary balanced circuitry. The resulting Quad Balanced configuration cancels even order distortion. Refer to figure 15.

All transistors are selected to have nearly constant current gain over the entire current range they must cover. Output transistors in particular, have matched uniform current gain, high current bandwidth product and large active region safe operating area. These Power Transistors are the very latest in semiconductor technology and incorporate a new design known as ThermalTrak™. Refer to figure 13. This allows for the instantaneous and accurate monitoring of the Power Transistor Temperature. The MC601 Power Output Circuitry has a specially designed bias circuit to take full advantage of the ThermalTrak™ Power Transistors and thus precisely controls the power amplifier operation over a wide range of music conditions with the benefits of lower distortion and cooler operation. Precision metal film resistors and low dielectric absorption film capacitors are used in all critical circuit locations.

The output signals of the two balanced circuits are coupled together in the unique McIntosh MC601 Output Autoformer. It provides low distortion power transfer at frequencies from below 20Hz to well



Figure 12

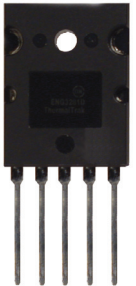

Figure 13



beyond 20,000Hz with optimum impedance points of two ohms, four ohms and eight ohms. The unequaled

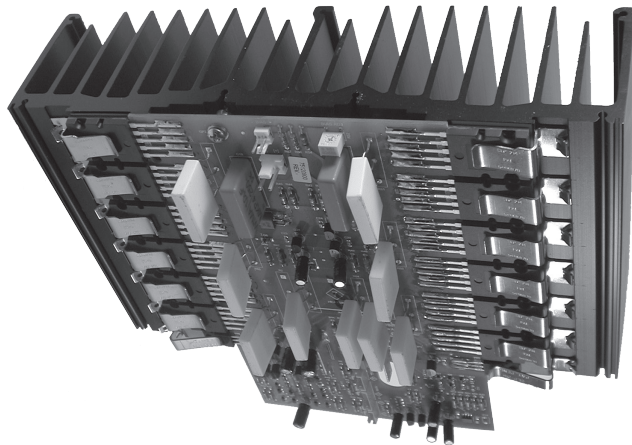

Figure 14

expertise of McIntosh in the design and manufacturing of autoformers is legendary in the high fidelity industry.

The high efficiency circuit design of the MC601 contributes to low operating temperatures. More than 1400 square inches of heat sink area keep the MC601 operating safely with convection cooling. No fans are needed. Refer to figure 14.

**Autoformers**

All solid state power amplifier output circuits work best into what is called an optimum load. This optimum load may vary considerably from what a loudspeaker requires. In the case of more than one loudspeaker connected in parallel, the load to the power amplifier may drop to two ohms or even less. A power amplifier connected to a load that is lower than

optimum, causes more output current to flow, which results in extra heat being generated in the power output stage. This increase in temperature will result in a reduced life expectancy for the amplifier.

The special Balanced Winding Autoformer creates an ideal match between the power amplifier output

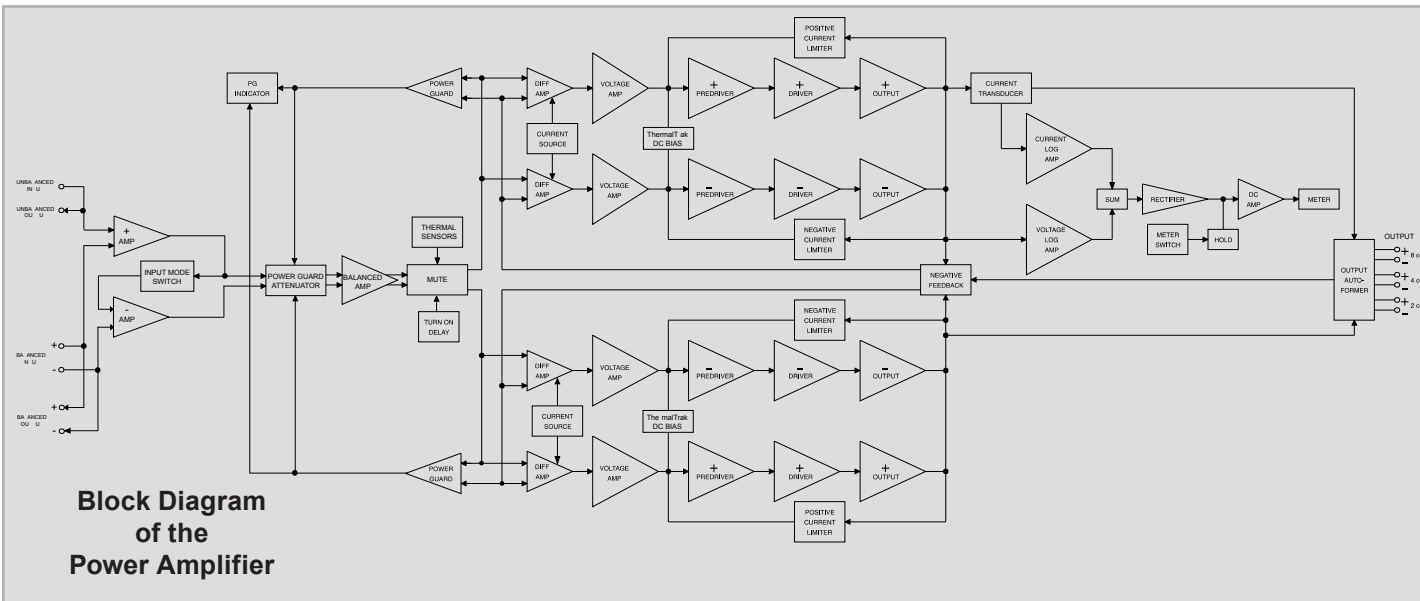

Figure 16

stage and the loudspeaker. Refer to figure 16.

There is absolutely no performance limitation with an Autoformer. Its frequency response exceeds that of the output circuit itself, and extends well beyond the audible range. Its distortion level is so low it is virtually impossible to measure.

In the rare event of a power amplifier output circuit failure, the McIntosh Autoformer provides absolute protection from possible damage to your valuable loudspeakers. The unequaled expertise of McIntosh in the design and manufacturing of Autoformers is legendary in the high fidelity industry. McIntosh engineers know how to do it right.



**Block Diagram of the Power Amplifier**

Figure 15

## Technical Description, con't

### Power Output Meter

The McIntosh MC601 has a large Output Watt Meter that responds 95% full scale to a single cycle tone burst at 2kHz. Refer to figure 17. Voltage and current outputs

are electronically measured, multiplied and fed to a special circuit that accelerates the pointer movement in the upward direction.



Figure 17

Refer to figure 25 on the next page. When the pointer reaches its peak it pauses only long enough for the human eye to perceive its position, then drops. It is almost 10 times faster than a professional VU meter.

A front panel switch is provided to change the meter to the Watts Hold Mode of operation. This allows fast upward movement of the pointer but greatly increases Hold Time at the peak of its travel. The highest power output of the source material is thus recorded.

### Protection Circuits

The MC601 incorporates the McIntosh Sentry Monitor Output Transistor Protection Circuit. Refer to Figure 18. There is absolutely no compromise in sonic performance with this circuit, and it ensures safe operation of the amplifier under even the most extreme operat-

ing conditions. The different types of protection circuits incorporated in the MC601 insure a long and safe operating life. This is just one of the many characteristics of McIntosh Power Amplifiers that make them world famous.

The MC601 also includes the unique patented McIntosh Power Guard circuit. Power Guard eliminates the possibility of ever overdriving the amplifier into clipping. Refer to figures 19, 20 and 21. An overdriven amplifier can produce both audible and inaudible distortion levels exceeding 40%. The audible distortion is unpleasant to hear, but the inaudible ultrasonic distortion is also undesirable, since it can damage valuable loudspeaker system tweeters. You will never experience the harsh and damaging distortion due to clipping.

The Power Guard circuit is a waveform comparator, monitoring both the input and output waveforms.

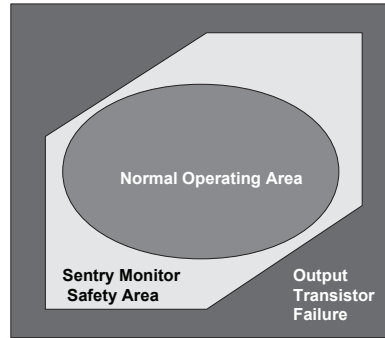

Figure 18

Input Test Signal  
(14kHz & 15kHz)

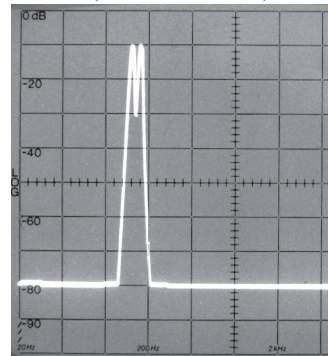

Figure 19

Under normal operating conditions, there are no differences between the shape of these waveforms. If the amplifier is overdriven, there will be a difference between the two signal waveforms. When the difference exceeds 0.3%, the Power Guard activates the PG light and a dynamic electronic attenuator at the amplifier input reduces the input volume just enough to prevent any further increase in distortion. The Power Guard circuit acts so fast that there are absolutely no audible side effects and the sonic purity of the music reproduction is perfectly preserved. The MC601 Power Amplifier with Power Guard is not limited to just the rated power output, but will actually produce distortion free output well above its rated power due to the McIntosh philosophy of conservative design.

### Power Supply Circuits

To compliment the design of the MC601 Power Amplifier Circuitry, there is a high current high voltage

Without Power Guard

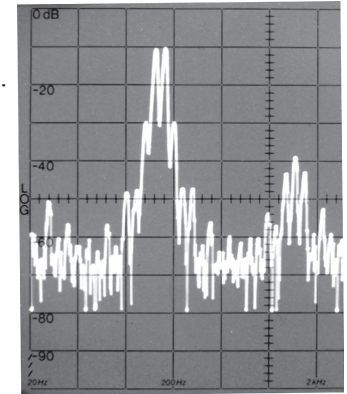

Figure 20

With Power Guard

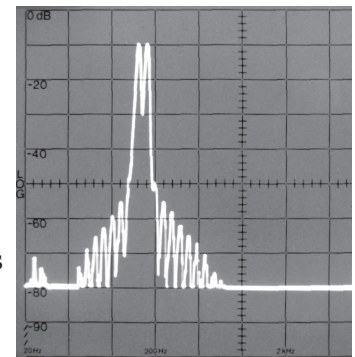

Figure 21

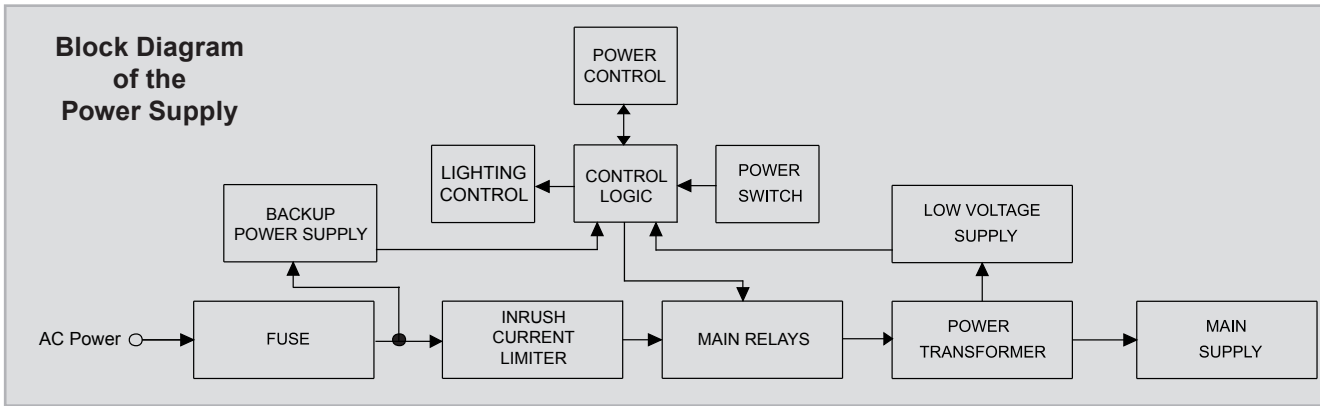

Figure 22

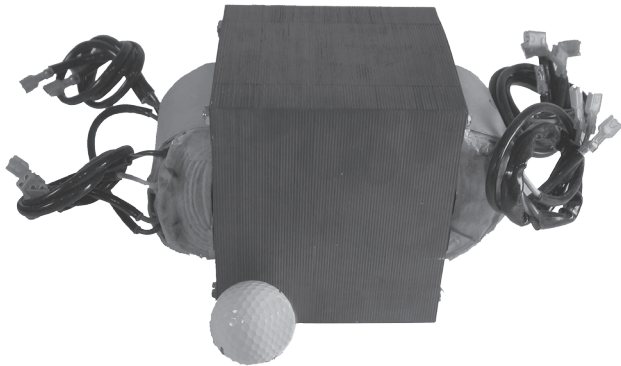

Figure 23

power supply. Refer to figures 22 and 25. The very large Power Transformer can supply over 13 amps of current. Refer to figure 23 (golf ball is for size comparison).

It is enclosed in the legendary McIntosh Potted Enclosures and weighs 28 lbs. The two super size main filter capacitors can store over 140 Joules of energy which is necessary for the wide dynamic range that "Digital Audio" demands. Refer to figure 24.

a circuit that provides remote Power Control from a McIntosh A/V Control Center. Refer to figure 25.

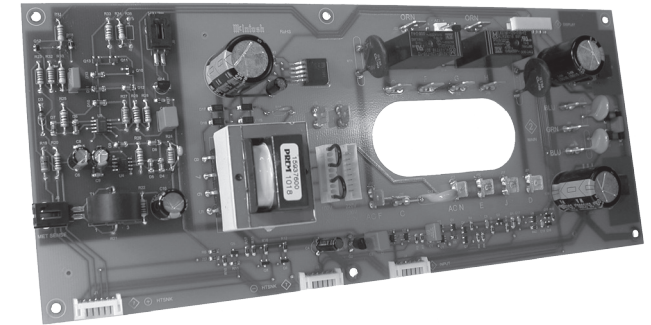

Figure 25

When the A/V Control Center is switched On, a (+5V) signal operates the power relay in the MC601. The MC601 also has two remote Power Control Out Jacks. The Power Control signal from these jacks are delayed by a fraction of a second so that the turn on power surge of the next power amplifier occurs at a later time. This helps prevent power circuit overload that could trip circuit breakers or blow fuses, a very important feature in a high power Home Systems employing multiple MC601 Power Amplifiers.



Figure 24

The power amplifier draws high current from the AC power line. Therefore, it is important that they plug directly into the wall outlet.

Also, most owners desire one power switch for the whole audio system. The MC601 is equipped with



## Specifications

### Power Output

Minimum sine wave continuous average power output is:

- 600 watts into 2 ohm load
- 600 watts into 4 ohm load
- 600 watts into 8 ohm load

### Output Load Impedance

2, 4 or 8 ohms

### Rated Power Band

20Hz to 20,000Hz

### Total Harmonic Distortion

0.005% maximum harmonic distortion at any power level from 250 milliwatts to rated power, 20Hz to 20,000Hz

### Dynamic Headroom

1.8dB

### Frequency Response

- +0, -0.25dB from 20Hz to 20,000Hz
- +0, -3.0dB from 10Hz to 100,000Hz

### Input Sensitivity (for rated output)

- 4.8 Volts Balanced
- 2.4 Volts Unbalanced

### Signal To Noise Ratio (A-Weighted)

- 96dB Balanced (124dB below rated output)
- 94dB Unbalanced (122dB below rated output)

### Intermodulation Distortion

0.005% maximum, if the instantaneous peak power output does not exceed twice the rated power output for any combination of frequencies from 20Hz to 20,000Hz.

### Wide Band Damping Factor

Greater than 40

### Input Impedance

- 22,000 ohms Balanced
- 22,000 ohms Unbalanced

### Voltage Gain

- 29dB, 8 Ohms
- 26dB, 4 Ohms
- 23dB, 2 Ohms

### Power Guard

Less than 2% Total Harmonic Distortion with up to a 14dB overdrive signal

### Power Control Input

5-15VDC, less than 1mA

### Power Control Output 1 and 2

- 12VDC, 50mA maximum total
- Output is delayed 0.2 seconds from turn On

### Power Requirements

*Field AC Voltage conversion of the MC601 is not possible. The MC601 is factory configured for one of the following AC Voltages:*

- 100V ~ 50/60Hz at 8 Amps
- 110V ~ 50/60Hz at 6.6 Amps
- 120V ~ 50/60Hz at 6.6 Amps
- 220V ~ 50/60Hz at 3.6 Amps
- 230V ~ 50/60Hz at 3.3 Amps
- 240V ~ 50/60Hz at 3.3 Amps
- Standby: less than 0.5 watt

*Note: Refer to the rear panel of the MC601 for the correct voltage.*

### Overall Dimensions

- Width is 17-1/2 inches (44.45cm)
- Height is 9-7/16 inches (23.97cm) including feet
- Depth is 22 inches (55.88cm) including the Front Panel, Handles and Cables

### Weight

93 pounds (42.18 kg) net, 126 pounds (57.15 kg) in shipping carton

### Shipping Carton Dimensions

- Width is 29-1/2 inches (74.93cm)
- Height is 17 inches (43.18cm)
- Depth is 29 inches (73.66cm)



**Packing Instructions**

In the event it is necessary to repack the equipment for shipment, the equipment must be packed exactly as shown below. It is very important that the four plastic feet are attached to the bottom of the equipment. Four 1/4 - 20x2-1/4 inch screws and washers must be used to fasten the unit securely to the bottom pad and wood skid. This will ensure the proper equipment location on the bottom pad. Failure to do this will result in shipping damage.

Use the original shipping carton and interior parts only if they are all in good serviceable condition. If a shipping carton or any of the interior part(s) are needed, please call or write Customer Service Department of McIntosh Laboratory. Refer to page 3. Please see the Part List for the correct part numbers.

Quantity	Part Number	Description
1	034052	Shipping carton top
1	034051	Shipping carton bottom
2	034054	Foam Pad (top and bottom)
2	034186	Foam Pad (front and rear)
2	034187	Foam Pad (sides)
1	034136	Inner carton top
1	034137	Inner carton bottom
1	034188	Foam Pad (inner carton)
1	034479	Shipping skid
4	401212	1/4 - 20x2-1/4 cap screw
4	104058	Flat washer

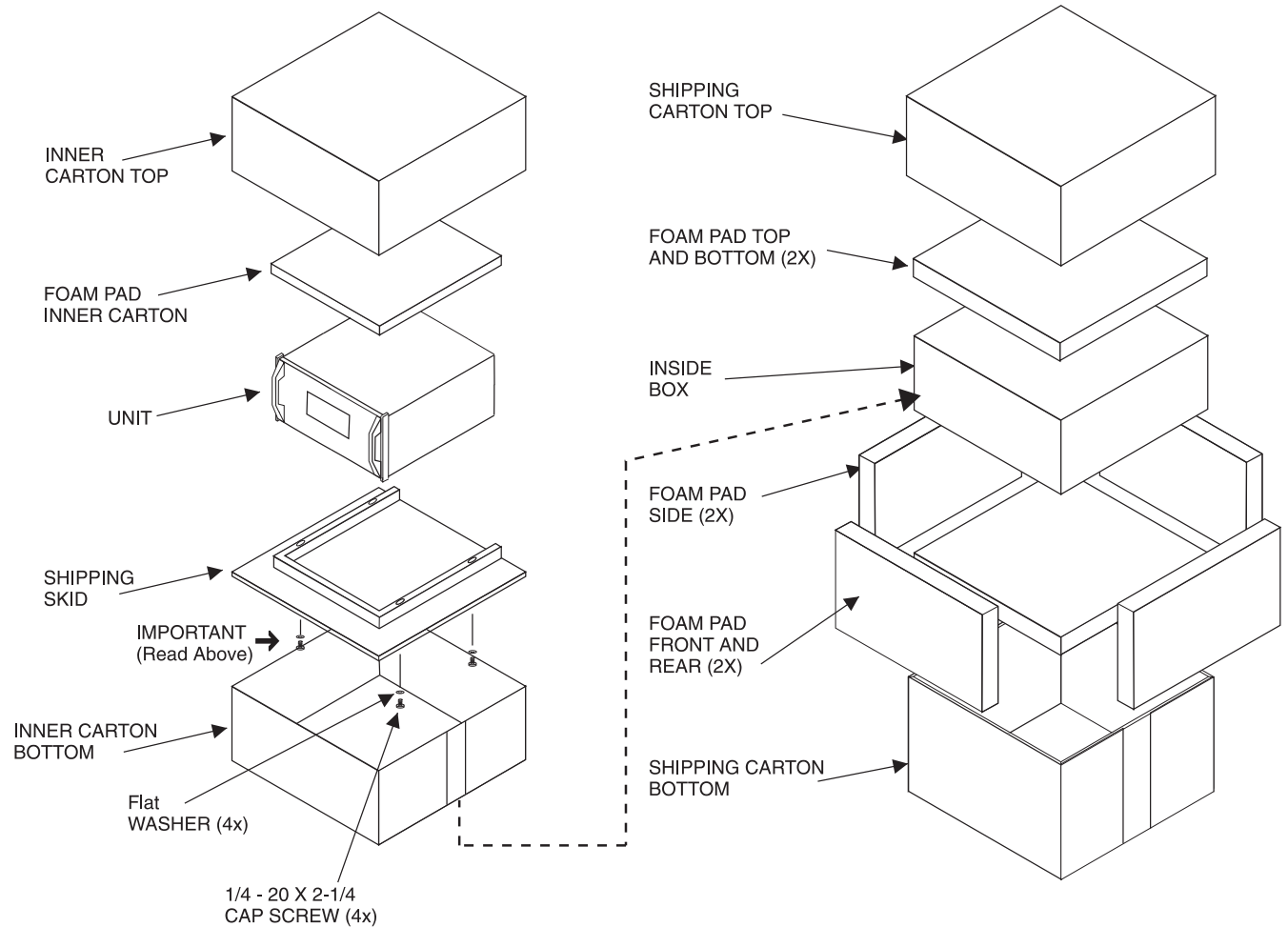



McIntosh Laboratory, Inc.  
2 Chambers Street  
Binghamton, NY 13903  
[www.mcintoshlabs.com](http://www.mcintoshlabs.com)

The continuous improvement of its products is the policy of McIntosh Laboratory Incorporated who reserve the right to improve design without notice.  
Printed in the U.S.A.